

Panasonic®

Network Color Camera
WV-NM100



A single camera can start your
networking experience.



**NETWORK
CAMERA**

The WV-NM100 plays an active part in a broad range of applications.



Home Security

View visitors approaching your home, and monitor the safety of children from almost anywhere.



Office Security

Observe entry points in office buildings, lobbies, and branch offices while remaining at your desk.

Field Management

Monitor manufacturing lines in the factory or storage facilities in the field.



Transmission of Information

Transmit images of store campaigns or special events.



Services

Monitor congestion in theme parks, libraries, hospitals and airport facilities.

*The above all pictures are simulated for the purpose of this explanation, actual images may differ.

At last, a high quality network color security camera that is ready for both JPEG & MPEG-4.

Panasonic introduces the new WV-NM100 camera. This new camera captures live images and displays them onto your personal computer. A digital video camera, a web server, and a network interface are integrated into one compact housing. The camera can be connected directly to an Ethernet terminal, enabling effortless network monitoring. Simply setup an IP address.

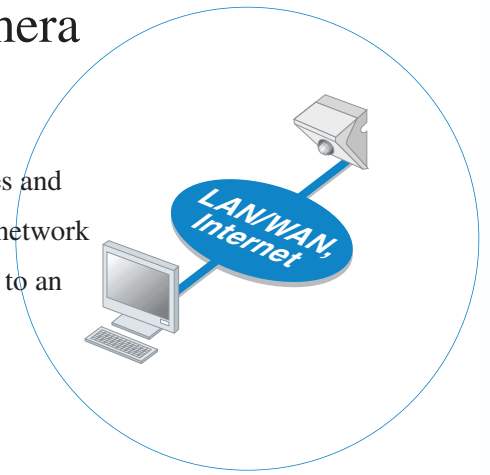

Easy Monitoring with a Web Browser

The WV-NM100 can handle images in JPEG format, the global standard for still image compression. Start monitoring by simply entering the IP address of the camera into the web browser.

Handles MPEG-4*, offering smoother images

In addition to JPEG, the WV-NM100 can use MPEG-4. MPEG-4 is the latest movie image compression format. View subjects with natural, smooth movements. Image sizes, quality and data distribution volume can be selected according to the network environment and communication speed.

(*For monitoring in MPEG-4 format, the supplied plug-in software should be installed.)

Works in low-light conditions

Thanks to the employment of imaging elements, coupled with the latest semiconductor technologies and low-light imaging technologies from surveillance cameras, the WV-NM100 demonstrates excellent low-light performance of 2 lx (0.2 fc) at electronic sensitivity 10x up. Images are clear even in low-light situations.

Controlling the Camera's Direction

Change the view in both the horizontal and vertical directions from a personal computer. With a wide field of view, covering 140 degrees for panning and 120 degrees for tilting, the WV-NM100 captures exactly what you need to see.



Software menu increases usability and effortless monitoring.

Easy to Use Graphical User Interface

One click monitoring

<One Time Pan Function>

One click of a button horizontally pans the camera back and forth within a range of 140 degrees.

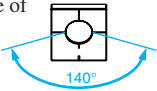

Automatic patrolling of up to 8 locations

<Preset Scan Function>

Just a single click brings up cameras in a preset sequence.

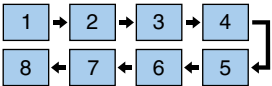

One click to view the desired camera location

<Preset Function>

One click brings up any camera set in up to 8 locations.

Camera Setting Menu



Selecting the optimum image

<Image Size>

JPEG: 3 sizes in VGA (640 x 480), QVGA (320 x 240) and QQVGA (160 x 120)

MPEG-4: 2 sizes in CIF (352 x 288) and QCIF (176 x 144)

<Selection of Image Quality>

JPEG: 4 options of Super Fine, Fine, Normal and Rough

MPEG-4: 3 options of Fine, Normal and Rough

Maneuvering the camera directions at will

<PAN/TILT Function>

Direct the camera up, down, right and left by maneuvering the icon on the screen with a mouse.

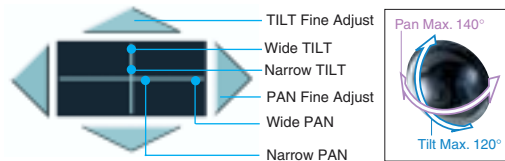

Get in close

<Zoom Function>

Just a single click will change the magnification of the display screen from x1.0, x1.5 or x2.0.



Monitor up to 8 cameras.

4 images in tiled windows x 2 image panes



Group A

Group B

View images from up to 8 cameras, in groups of four, in a tiled window. This ensures fast, efficient operation since it's not necessary to call up different windows from other areas.

Enhanced Security Due to Restricted Access

Restrict camera access by host authentication using the IP address of your personal computer, as well as authentication utilizing user name and password. Three access levels are available. In addition, the WV-NM100 camera has an IP address and can function as a web server. This enables the cameras to be organized under the control of your network administrator, as well as configuring additional security by using a firewall.

Three Access Levels

	Setting	Control	Browsing of Image
Level 1	○	○	○
Level 2		○	○
Level 3			○



Checking the Alarm Image

One click reproduction of desired images from up to 60 alarm archives

<Alarm Log List>

Check the date, time, and type of alarms at a glance, and call up the desired image just by clicking a button.

Storing up to 60 alarm images

The WV-NM100 is capable of storing up to 60 alarm images (JPEG only) within the camera body. Later, archive images to the FTP server for long-term storage.

Easy checking of alarm image details

<Control Button>

A simple mouse operation on the screen icon will enable reproduction, reverse reproduction, etc. of alarm images.

Alarm Log List Menu



JPEG images can either be sent forward or backward one frame at a time.

Images can be increased up to twice the size of the original.

Simple Menu Selection

Top Menu



The Initial Software Menu Screen allows quick access to the "Camera Control," "Alarm List," and "Setting" menus from the Top Menu.

Basic Setting Menu



This menu allows for the adjustment of settings for intended applications and the network environment, such as camera name, JPEG/MPEG-4 modes, image size, and image quality.

Preset Registration Menu



Register up to 8 camera locations in advance. Designate a screen title consisting of up to 32 alphanumeric characters for each of the camera positions.

Efficient Monitoring with Many Convenient Functions

Video Motion Detector (VMD) Function

Detect any motion within the camera's field of view and output an alarm signal. This allows more time to operate external equipment, change the directions of cameras, initiate recording, etc. Up to four locations and three detection levels can be set for each camera.



Automatic Imaging/Transfer Function

This function designates the conditions, such as day, time, or time interval, etc. to automatically take/transfer images. By using this function, you can also update images automatically on your home page.

Pre-/Post-Alarm Function

When an alarm is sounded, 30 images totally before and after the alarm activation can be continuously stored to ensure the capture of important video details.



Alarm Mail & Image Transfer Function

This function automatically notifies of alarms from the motion detector or external sensors by e-mail. You can attach one alarm image.

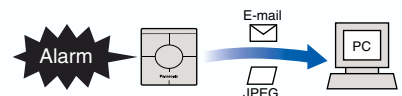

Via an Intranet or Internet. The versatility to accommodate either system.

SYSTEM EXAMPLES

1 Monitoring System Utilizing an Intranet

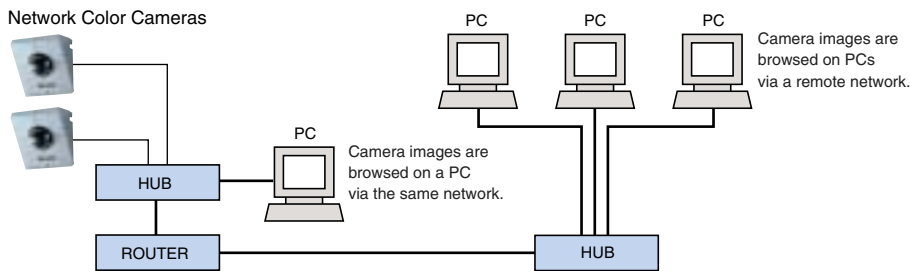

2 System utilizing the Internet

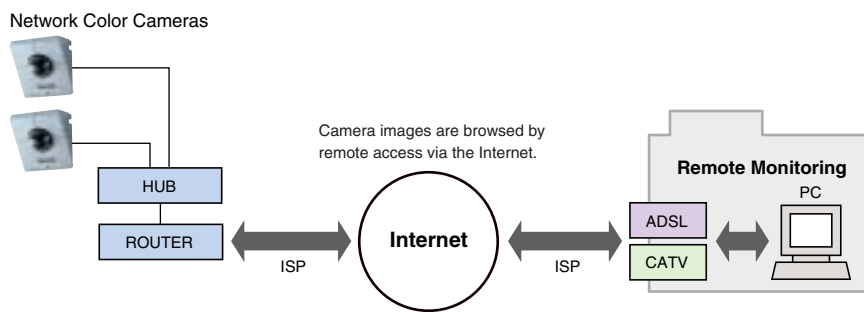

MAJOR OPERATING CONTROLS

Front View



LED Display

Rear View

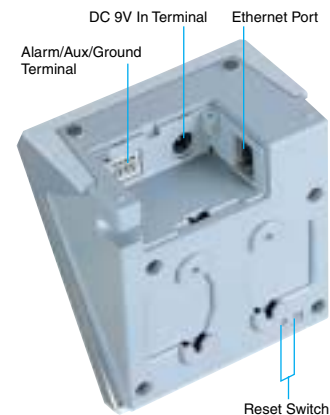

SPECIFICATIONS

Camera Function	
Pick-up Device	1/4-type solid state image sensor
Effective Pixels	660 (H) x 492 (V) pixels
Min. Illumination	2 lx (electronic sensitivity x 10), 10 lx (electronic sensitivity off)
Picture Sampling at Image Sensor	30 ips
Lens	Fixed focal type
Panning Angle	140 degree (±70°)
Tilting Angle	120 degree (+30° - -90°)
Pan / Tilt Preset	Eight (8) position
Network Function	
Image Compression Type	JPEG / MPEG-4 Selectable (requires standard plug-in software for MPEG-4)
Image Size	JPEG: VGA (640 x 480), QVGA (320 x 240), QQVGA (160 x 120) MPEG-4: CIF (352 x 288), QCIF (176 x 144)
Protocol Supported	TCP/IP, UDP/IP, HTTP, FTP, SMTP, RTP, DNS, DDNS, DHCP, ARP, BOOTP, SNMP, NTP
Network	10Base-T / 100Base-TX (RJ-45 x 1)
General	
Alarm Interface	Alarm input x 1, Alarm output x 1, Aux output x 1
Power Supply	DC9V (AC Adaptor is standard accessory)
Power Consumption	9W
Ambient Operating Temperature	0°C - +40°C
Dimensions	93 (W) x 95 (H) x 61.5 (D) mm
Weight (approx.)	180g (0.4 lbs.) (except AC adaptor)

APPEARANCE

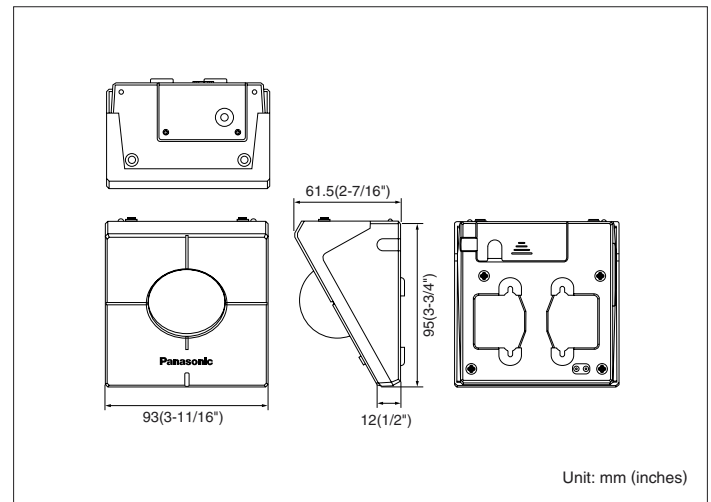

• All pictures in menu are simulated. • Weights and dimensions are approximate. • Specifications are subject to change without notice. • These products may be subject to export control regulations.

Panasonic

Panasonic Digital Communications & Security Company
Unit Company of Matsushita Electric Corporation of America

Security & Vision Systems Group

Security Systems

www.panasonic.com/cctv

Executive Office : One Panasonic Way 3E-7, Secaucus, New Jersey 07094

Zone Office

Eastern : One Panasonic Way, Secaucus, NJ 07094 (201) 348-7303

Central : 1707 N.Randal Road, Elgin, IL 60123 (847) 468-5205

Western : 6550 Katella Ave., Cypress, CA 90630 (714) 373-7840

DISTRIBUTED BY:

PANASONIC CANADA INC.

5770 Ambler Drive, Mississauga, Ontario, L4W 2T3 Canada (905) 624-5010

PANASONIC SALES COMPANY

DIVISION OF MATSUSHITA ELECTRIC OF PUERTO RICO, INC.

San Gabriel Industrial Park 65th Infantry Ave. KM. 9.5 Carolina, P.R. 00985 (809) 750-4300

Printed in Japan

WV-JHNM100C(2P-500A)